

Article Info

Received: 22 Mar 2015 | Revised Submission: 12 Apr 2015 | Accepted: 22 May 2015 | Available Online: 15 Jun 2015

Single Phase Series Resonant Inverter with Automatic Control

Meenakshi Chaudhary, Shikhar Agarwal**, Piyush Karanwal*** and Amit Kumar*****

ABSTRACT

In this paper, a novel DC-AC single phase resonant inverter is proposed. When the switches are turned on and off, a conventional inverter generates switching loss because of hard switching. Thus inverter losses are increased. In this paper some protective measures have taken so that losses should be minimized and system become more efficient results in high efficiency of inverter.

Keywords: *Resonant Inverter; Resonant Condition Switching Techniques; Automatic Control.*

1.0 Introduction

Now a day's growing demand for higher power density and low profile in power converter has forced to increase switching frequency. Operation at higher frequencies considerably reduces the size of passive components, such as transformers and filters, however switching losses have been obstacle to high frequency operation. In order to reduce these losses related to switching and to allow high frequency operation, resonant switching techniques have been developed. Series resonant inverters are those in which resonating components and switching devices are in series with the load to form an under damped circuit. Series resonant load are fed by voltage fed inverter. At high switching frequencies, higher efficiency can be obtained by making switching device to turn on and turn off at the zero crossing. This technique is called "Soft Switching," which can be subdivided into two methods: Zero-Voltage Switching (ZVS) and Zero-Current Switching (ZCS). When the switching device voltage is set to zero right before turn on of switch, switching loss during turn on can be eliminated and this refers to ZVS. ZCS eliminates the turn off switching loss by making current to zero in the circuit right before turning it off. Voltage and Current in switching circuit is made to zero using resonance condition which is achieved by L-C resonant circuit.

This paper proposes a resonant inverter and resonant inverter is that in which switching devices are placed in series in series with the load. It works on resonant condition, which occurs when inductive reactances are equal to the capacitive reactances

.When the switches are turned on and off, a conventional inverter generates switching losses because of hard switching and we cannot control its output voltage while resonant inverter cannot generate switching losses because of soft switching techniques used in proposed system. Hard switching of power semiconductor devices produces high power losses and high stress in semiconductor devices. As we know power loss is directly proportional to the switching frequency, so as switching frequency increases power loss also goes on increasing and results in lower efficiency of the system due to which switching frequency is kept under maximum frequency. Resonant inverter is a type of voltage source inverter or says voltage fed inverter (VFI). In VFIs using thyristors some type of forced commutation is usually required. In case VFIs are made up of using GTOs, power transistors, power MOSFETS or IGBTs, self commutation with base or gate signals is employed for their controlled turn on and off. In conventional inverters external circuitry is required for controlling the output voltage like AC voltage controllers etc. This increases the size and cost of inverter circuit but we can control the output power and voltage of resonant inverter by varying the switching frequency. The need to control the output voltage of an inverter occurs to cope with the variations of DC input voltage, for voltage regulation, for the constant volts/ frequency control requirement. Switching frequency can be varied by varying the

*Corresponding Author: Department of Electrical Engineering, MIT, Moradabad, Uttar Pradesh, India (E-mail: meen.choudhary1192@gmail.com)

**Department of Electrical Engineering, MIT, Moradabad, Uttar Pradesh, India

***Department of Electrical Engineering, MIT, Moradabad, Uttar Pradesh, India

****Department of Electrical Engineering, MIT, Moradabad, Uttar Pradesh, India

time period T of gate signal. Due to high switching frequency the size of resonating components are small. Resonant tank circuit used in proposed system comprises of inductor and capacitor. Inductor is placed in series with switches to minimize zero turn on switching losses and capacitor is placed in parallel with the switches to minimize turn off losses. Switches will produce alternating current and due to change in alternating current at the primary side of transformer produces alternating voltage at the secondary side.

In proposed inverter automatic control is done due to which power is conserve. Automatic control is done using LDR (Light Detecting Resistance) and relay. Voltage regulator is also used for converting the voltage according to the requirement. 555 timer IC is used here as clock pulse generator and it will work in astable mode and output of this IC is square wave which is then applied to both the switches (MOSFET) and output of these switches are then forward to transformer which step up the voltage to 220 V. L-C resonant circuit is used to filter out the fluctuations from the circuit because it will act as filter circuit.

2.0 Series Resonant Inverter

Resonance occurs while the inductor and capacitor exchanges energy. Resonant inverters are electrical inverters based on resonant current oscillations. In series resonant inverters the resonating components and switching device are placed in series with the load to form an under damped circuit. The current through the switching devices fall to zero due to the natural characteristics. In voltage fed inverters, two switches of the same inverter leg cannot be turned-on at the same time, otherwise short circuit occurs. The time between the turning-off of one of these switches and the turning-on of the other is called dead-time. With increase in switching frequency size of a transformer and filter is reduced but switching loss reduces the efficiency of the system, as more losses are generated at a high frequency.

Fig. 1. General Block Diagram of Resonant Inverter

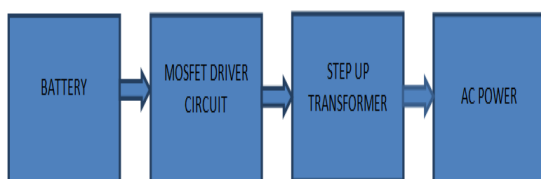

Switching loss can be partly mitigated by connecting a snubber circuit parallel to the switching circuit, but the total amount of switching loss generated in the system remains the same. The loss avoided has been moved to the snubber circuit. At high switching frequencies, higher efficiency can be obtained by making device to turn on or off at the zero crossing. This technique is called “Soft Switching,” Which can be subdivided into two methods: Zero-Voltage Switching (ZVS) and Zero-Current Switching (ZCS). When the switching device voltage is set to zero right before turn on Of switch, switching loss during turn on can be eliminate and this refers to ZVS. ZCS eliminates the turn off switching loss by making current to zero in the circuit right before turning it off. Voltage and Current in switching circuit is made to zero using resonance condition which is achieved by L-C resonant circuit. Resonant inverter also reduces the problem of electromagnetic interference at high frequency. Resonance happens when reactance are equal.

$$XL = XC \text{ and } XL = j\omega L = j2\pi f L [\Omega]$$

$$XC = 1 / j\omega C = 1 / j2\pi f C [\Omega]$$

$$Z = \sqrt{R^2 + (\omega L - 1/\omega C)^2}$$

$$\text{Resonant frequency is given by } Fr = 1 / 2\pi \sqrt{LC}$$

Where XL = inductive reactance XC= Capacitive reactance and Z = impedance of the resonant circuit

3.0 How Single Phase Series Resonant Inverter Works

Fig. 2. Circuit Diagram of Single Phase Series Resonant Inverter

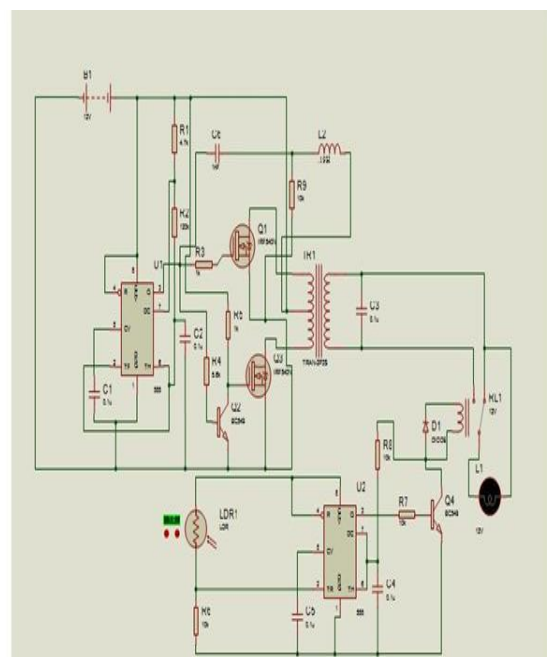

4.0 Table Shows Components with Their Ratings and Quantity Used

Components Used	Rating	Quantity
NE555 Timer IC	-	2
BC549 NPN Transistor (Q2,Q4)	-	2
DC Relay	5Amperes	1
Step Up Transformer	12-0-12 V, 3Amp	1
Capacitors (C1,C2,C3,C4,C5)	0.1µF	5
Capacitor(C6)	1nF	1
Inductor(L2)	0.19H	1
IRF540N,N Channel MOSFET	5.6 Amp, 100V	2
Resistors(R1)	4.7K	1
(R2)	120K	1
(R3,R5)	1K	2
(R4)	5.6K	1
(R6,R7,R8,R9)	10K	4

Fig: 3. Hardware Implementation on PCB board

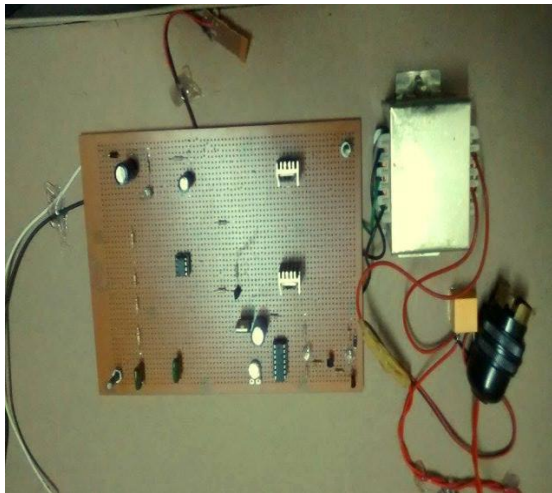

As we know that resonant inverter is a voltage source inverter so it is fed with DC voltage of 12V as input with the help of 12V battery. Diode is used in the circuit at input terminals for unidirectional power supply so that circuit cannot damage. At starting some fluctuations will occur so we will use capacitor to remove out fluctuations. After that for checking out the power supply, we will use one resistance and LED .LED is for checking power supply and with it resistance is used to drop out the voltage according to the requirement.

NE555 Timer IC: NE555 Timer IC is used as clock pulse generator. This IC works in as table multivibrator mode and has two states both of which are quasi stable. It does not have a stable state at all. That means the as table circuit will always keep changing its state. External trigger is not required for the as table multivibrator. It is also used as square

wave generator and called as a free running multivibrator. The “ON” and “OFF” times of the output voltage waveforms are determined by the values of R1 and R2 along with the capacitance C which are inserted at pin no 6, 7. some variations occur due to time constant ($\tau=RC$).When τ increases, resistance also increases and so the capacitance is also increases ,results in decrease in the frequency and we have to make frequency 50Hz .So to make the frequency 50Hz we have to decrease the value of resistance. .The output of Timer IC is taken from pin no-3 which is a clock pulse .Output voltage of 555 Timer IC with capacitor charging is shown in the figure below.

Fig: 4. Waveform Showing Capacitor Voltage And output of 555 Timer

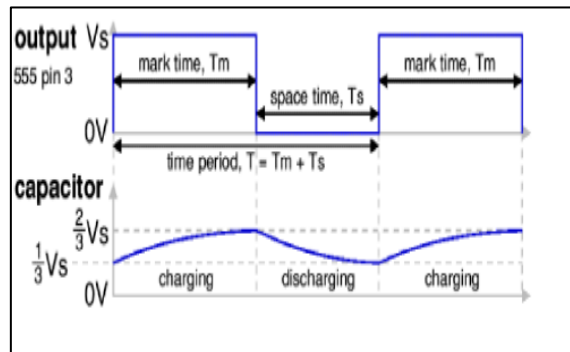
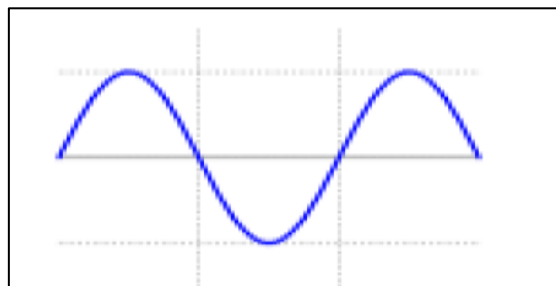

Fig: 5. Showing The Output Voltage Waveform Transformer



Duty of 555 timer can be calculated as:
 Duty cycle= (conduction time/ Total time)*100

$$\text{Duty cycle} = \frac{(R1+R2)}{(R1+2R2)} * 100$$

$$\text{Total Time of 555 Timer IC in astable mode} = 0.693(R1+2R2)*C.$$

Output of Timer IC is fed to both the N channel type MOSFET IRF5409(Q1,Q2).The current of pin-3 of IC will flow in two ways, first through R3 to gate of Q1 and, second ways will flow to Q2 through transistor BC549 as inverter logic form to reverse signal difference first ways. Next current flow to gate of Q3 to also driver the transformer. Both the

mosfets are turn on and off alternately to avoid short circuiting. When 555 Timer IC generates positive pulse then Mosfet Q1 will not turn on and then this positive pulse is transferred to npn transistor Q2 which gets turn on and it will turn on the mosfet Q2. When Timer IC generates negative pulse then mosfet Q1 will turn on .

In this both the mosfet will turn on and off alternately and alternating pulse which is fed to the step up transformer (12-0-12V, 3 amperes) which step up the voltage to 220V AC and given to the load.

Switching Losses can be calculated as:

$$P_{sw} = 1/2 * V_{sw} * I_{sw} * f_s (T_{on} + T_{off})$$

Where: P_{sw} = switching loss

V_{sw} = switching voltage I_{sw} = switching current.

f_s = switching frequency.

T_{on} = switch turn-on time.

T_{off} = switch turn-off time. The loaded

Quality Factor is given as $Q = \omega L / R = 1 / \omega C R = Z / R = (\sqrt{L/C}) / R$ Automatic Control System: For automatic control of circuit here we use DC relay, LDR, 555 Timer IC, NPN transistor BC549, switch, voltage regulator 7805. In this project voltage regulator is used to convert the voltage into 5V as per the requirement of the circuit. In 555 Timer input is fed at pin-2, when light falls on LDR in day its resistance become low, then -5V at LDR will convert into positive 5V, pnp transistor remain turn off as it will get turn on only from negative voltage .

when light falls on LDR in night time its resistance goes high and it will convert positive pulse into negative pulse and pnp transistor will turn on, which will turn on npn transistor and it will turn on DC relay results in glowing of load.

Relay used here is DC relay. Relay requires a current through their coils, for which voltage is applied.

This voltage for relay can be DC low voltages upto 24V or could be 220V.

Fig: 6. Basic Diagram Showing the Operating Principle of a Relay

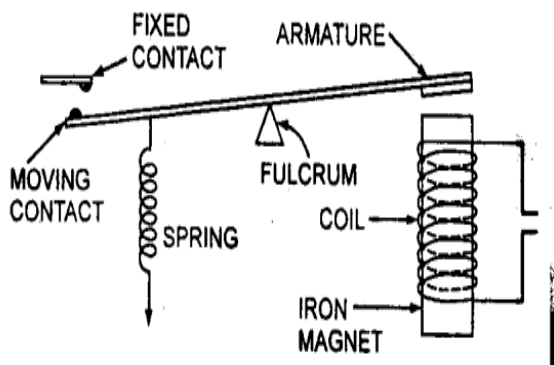
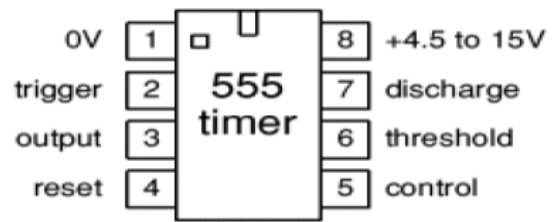

Fig: 6. Showing NE555 Timer



5.0 Conclusion

In this paper, I proposed a series resonant inverter using soft switching techniques namely zero voltage switching and zero current switching .In this topology all switches perform a soft switching by resonance between the resonant inductor and capacitor. So, the proposed technology can reduce switching losses and voltage stress and results in high efficiency and better voltage regulation. By using low power and low rating semiconductor devices, size and cost of this project is reduced.

References

- [1] S. Sanauilla Sunny, M. abid Nayumuddin, A Novel DC-AC Single Phase Resonant Inverter Using Soft Switching Boost Converter ,International Journal Of Advances in Science and Technology, 3(1), 2011
- [2] I. Jamil, Z. Jinquan, R. Jamil, Analysis, Design and Implementation of Zero Current Switching Resonant Converters DC-DC Buck Converters, International Journal of Electrical and Electronics Engineering, 2(2), 2013, 1-12
- [3] P. S. Bhimra, Power Electronics
- [4] R. Nithya, N. P. Anila, J. Mohan, Analysis of Series Resonant Inverter Using Hysteresis Current Control, IJETT, 8(2), 2014
- [5] Z. A. Jaffery, S. K. Chaudhry, Quality Assessment of a Single Phase Resonant Inverter, IJPEDS, 2(4), 2012, 364-370
- [6] J. Ben Klaassens, Marines P. N. Van Wesenbeeck, Hian K. Lauw, Series Resonant Single Phase AC-DC Power Supply With Control of Reactive Power, IEEE Transactions on Power Electronics, 7(1), 1992
- [7] J. David Irwin, The Power Electronics Handboo